

ESQUEMA DE MONTAGEM

ASSEMBLY INTRUCTION / INSTRUCCIONE DE MONTAJE

MOVEIS
RUD RACK

MESA DE CABECEIRA THOR

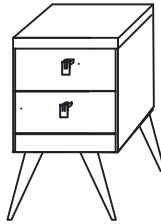

Dear editor :

For a better assembly of our product, follow these instructions:

*The mobile should be mounted lying face-up .

*Separate the parts and accessories .

*insert the bolts.

*screw pins girofix.

After seating of the parts and fixing screws, the furniture should be lifted:

*The fund should be nailed to the square of the observing mobile.

Leave the doors and removable shelves to be fitted and adjusted last .

Sr. director :

para un conjunto mejor de nuestro producto, siga estas instrucciones:

*El movil debe ser montado acostado boca arriba .

*Separe las partes y accessories .

*Introducir los tornillos.

*El cable girofix pins .

Despues de asientos de las piezas y tornillos de fijacion, los muebles deben ser levantados:

*El fondo debe ser clavado en la plaza de los moviles de observacion.

Deje las puertas y estantes extraibles para montary ajustar los ultimos.

Caro montador :

Para melhor montagem de nosso produto, siga as seguintes instruções:

*O movel deve ser montado deitado coma frente para cima .

*Separe as peças e acessórios .

*Encaixe as cavilhas .

*Parafuse os pinos de girofix .







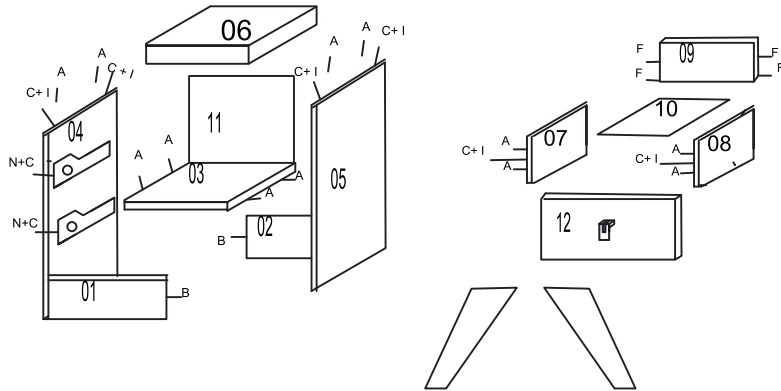



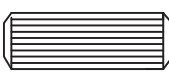

*Após o encaixe das peças e fixação dos parafusos, o movel deve ser levantado:

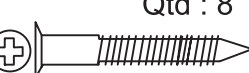
*Os fundos devem ser pregados observando o esquadro do movel .

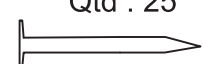
Deixe as portas paralelas removíveis para serem encaixadas e reguladas por ultimo

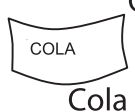

COD	DESCRIÇÃO	DESCRIPTION	DESCRIPCION	QTD	MEDIDA
1	RODA PE FRONTAL	FRONT FOOT WHEEL	PIE DE PAGINA DELANTEIRO	1	400 X 70 X 15
2	RODAPE TRASEIRO	REAR WHEEL	PIE DE PAGINA TRASERO	1	400 X 70 X 15
3	BASE	BASE	BASE	1	400 X 338 X 15
4	LATERAL ESQUERDA	LEFT SIDE	LATERAL ESQUIERDO	1	380 X 370 X 15
5	LATERAL DIREITA	RIGHT SIDE	LATERAL DERECHO	1	380 X 370 X 15
6	TAMPO	COVER	MESA	1	450 X 385 X 25
7	LATERAL DE GAVETA ESQUERDA	LEFT DRAWER SIDE	LADODELCAJON IZQUIERDO	2	350 X 110 X 12
8	LATERAL DE GAVETA DIREITA	RIGHT DAWER SIDE	LADO DEL CAJON DERECHO	2	350 X 110 X 12
9	CONTRA FUNDO	AGAINST BACKGROUND	CONTRA EL FONDO	2	352 X 90 X 12
10	FUNDO DE GAVETA	DRAWER BOTTOM	FONDO DEL CAJON	2	362 X 355 X 2,8
11	FUNDO TRASEIRO	BACK BOTTOM	FONDO TRASERO	1	425 X 350 X 2,8
12	FRENTE DE GAVETA	DRAWER FRONT	FRENTE DE CAJON	2	395 X 150 X 15

A  Qtd : 16 Cavilha de madeira 6 X 30	B  Qtd : 4 Parafuso 5 X 50 S/ Ponta	C  Qtd : 32 Parafuso 3,5 X 14	D  Qtd : 32 Parafuso 3,5 X 12	E  Qtd: 4 Parafuso 4 X 16	F  Qtd : 8 Parafuso 3 X 30	
G  Qtd : 2 Puxador Viena	H  Qtd : 25 Prego 10 X 10	i  Qtd : 8 Cantoneira	j  Qtd : 1 Cola	L  Qtd : 1 Logó	M  Qtd : 4 Pe'	N  Qtd : 2 Corrediça telescopia

Av.hungria,2270.Pq Industrial Tribulato fone/fax +55 43 3256-8818 - Rolandia-PR-BR e-mail:rudrack@rudrack.com