

MÓVEIS
RUD RACK

Painel RR 1491

Caro Montador:

Para uma melhor montagem de nosso produto, siga as seguintes instruções:

- * O Móvel deve ser montado deitado com a frente para cima.
- * Separe as peças e acessórios.
- * Encaixe as cavilhas.
- * Parafuse os pinos de Girofix.

Após o encaixe das peças e fixação dos parafusos, o móvel deve ser levantado:

* Os fundos deverão ser pregados observando o esquadro do Móvel.
Deixe as portas e prateleiras removíveis para serem encaixadas e reguladas por último.

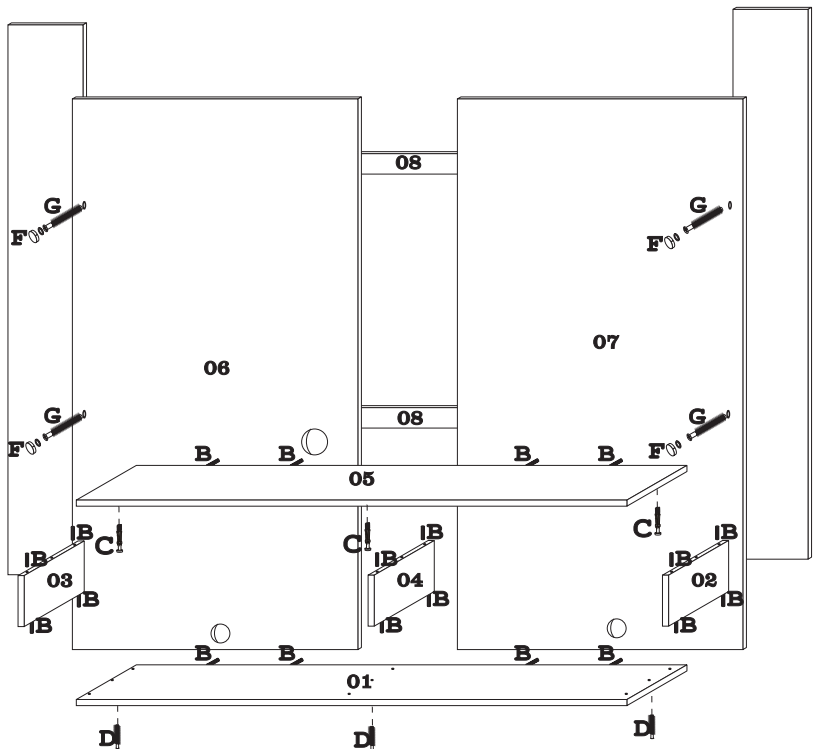
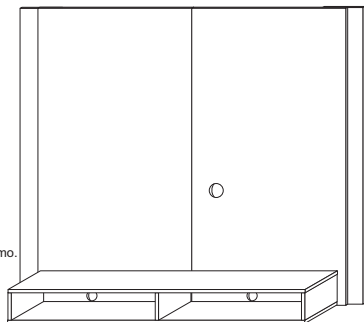

Esquema de Montagem

Assembly Instructions / Instruccion de Montaje

Dear Editor:

For a better assembly of our product, follow these instructions:

- * The Mobile should be mounted lying face-up.
- * Separate the parts and accessories.
- * Insert the bolts.
- * Screw pins Girofix.

After seating of the parts and fixing screws, the furniture should be lifted:

- * The fund should be nailed to the square of the observing Mobile.
- Leave the doors and removable shelves to be fitted and adjusted last

Sr. Director:





Para un conjunto mejor de nuestro producto, siga estas instrucciones:

- * El móvil debe ser montado acostado boca arriba.
- * Separe las partes y accesorios.
- * Introducir los tornillos.
- * El cable Girofix pins.

Después de asientos de las piezas y tornillos de fijación, los muebles deben ser levantadas:

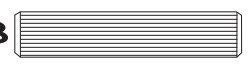
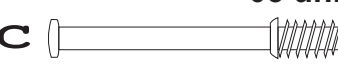
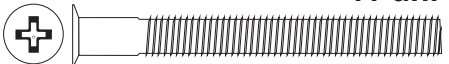
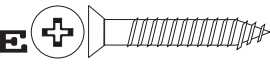
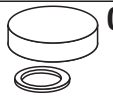
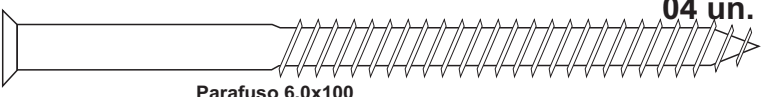
- * El fondo debe ser clavado en la plaza de los móviles de observación.
- Deje las puertas y estantes extraíbles para montar y ajustar los últimos

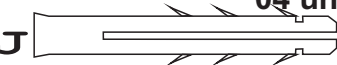
Cód.	Descrição	Description	Descripción	Qtd.	Medida
01	BASE	BASE	BASE	01	1,350X0,255
02	LATERAL DIREITA	RIGHT SIDE	LADO DERECHO	01	0,253X0,125
03	LATERAL ESQUERDA	LEFT SIDE	LADO IZQUIERDO	01	0,253X0,125
04	DIVISÓRIA	SPLIT	PARTICIÓN	01	0,245X0,125
05	TAMPO	TAMPO	CUBIERTA	01	1,350X0,255
06	PAINEL ESQUERDO	LEFT PANEL	EI PANEL IZQUIERDO	01	1,350X0,700
07	PAINEL DIREITO	RIGHT PANEL	PANEL DERECHO	01	1,350X0,700
08	ALINHADOR DE PAINEL	PANEL ALIGNMENT	ALINEADOR PANEL	02	0,500X0,050
09	TRAVESSA LATERAL DIR E ESQ	RIGHT AND LEFT SIDE TRANSFER	RAIL DERECHO E IZQUIERDO	01	1,348X0,184

<p>A  04 un.</p> <p>Cavilha de Madeira 6 x 20 Tarugo de madeira/Wood Dowel</p>	<p>B  16 un.</p> <p>Cavilha de Madeira 6 x 30 Tarugo de madeira/Wood Dowel</p>	<p>C  03 un.</p> <p>Pino do Girofix Tornillo del Girofix/Girofix Pin</p>	<p>D  11 un.</p> <p>Parafuso 5,0x50 S/Ponta Tornillo/Screw</p>	<p>E  16 un.</p> <p>Parafuso 4,0x25 Chata Tornillo/Screw</p>	<p>F  04 un.</p> <p>Botão Decorativo Decorative Button/Botón Decorativo</p>
<p>G  04 un.</p> <p>Parafuso 6,0x100 Tornillo/Screw</p>	<p>H  04 un.</p> <p>Logomarca Logo</p>	<p>I  03 un.</p> <p>Castanha do Girofix Girofix</p>	<p>J  04 un.</p> <p>Bucha Plástica Plastic Loofah/Casquillo de Plástico</p>	<p>K  03 un.</p> <p>Passa Fio Thread Tools/Pasar Wire</p>	

1º Passo

Vista Traseira:
Back view/Vista Trasera

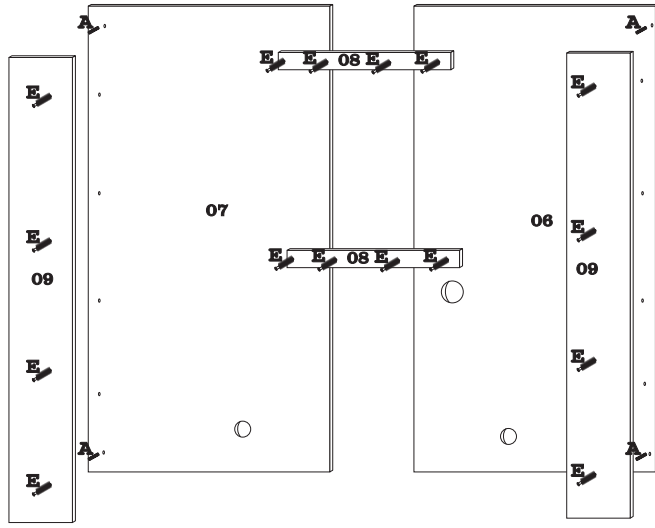

3º Passo

Vista Traseira:
Back view/Vista Trasera

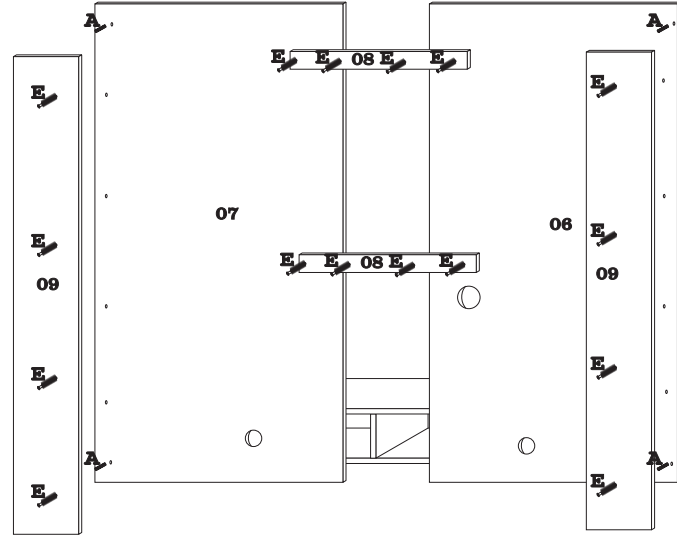

5º Passo

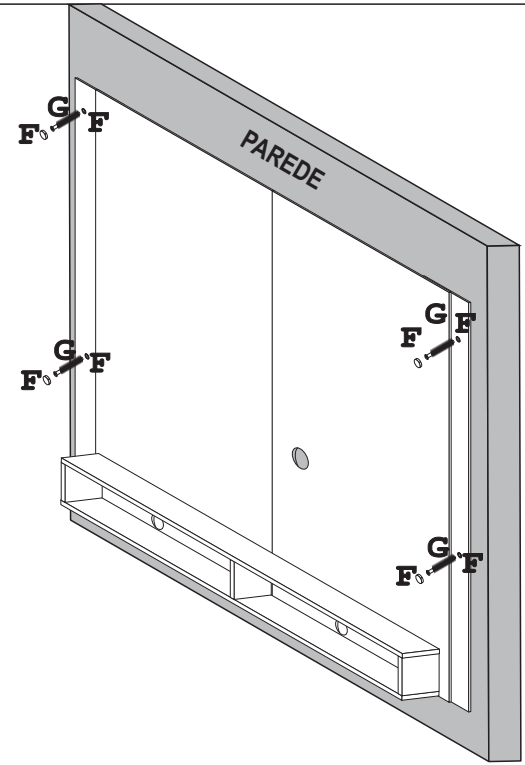

2º Passo

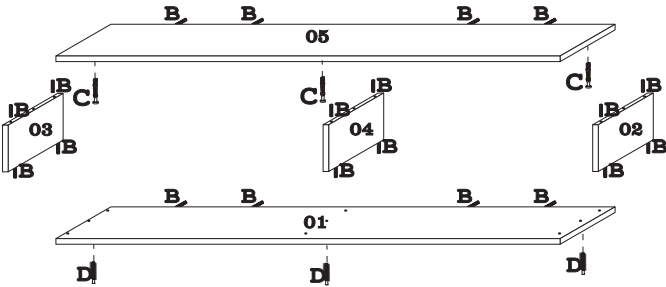

4º Passo

Vista Traseira:
Back view/Vista Trasera

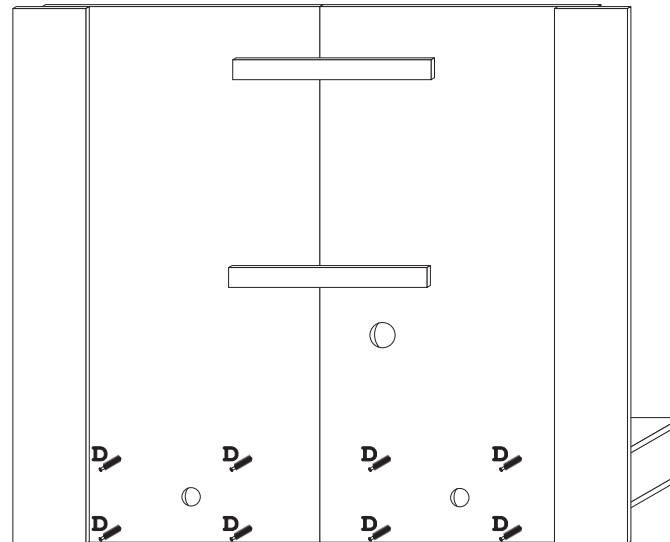

Aspecto Final:

